

**Main Product Characteristics:**

$V_{DS}$	1200V
$I_D$	87A
$R_{DS(on)}$	32m $\Omega$

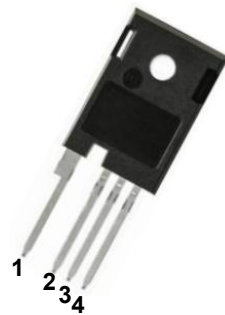

TO -247-4L

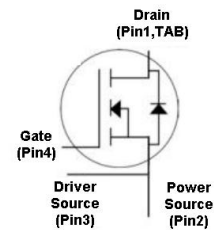

Schematic Diagram

**Features and Benefits:**

- High blocking voltage with low on-resistance
- High speed switching, very low switching losses
- High blocking voltage with low on-resistance
- Fast intrinsic diode with low reverse recovery ( $Q_{rr}$ )
- Temperature independent turn-off switching losses

**Applications:**

- On-board charger/PFC
- EV battery chargers
- Booster/DC-DC converter
- Switch mode power supplies

**Absolute Max Rating:**

Symbol	Parameter	Value	Units
$V_{DS}$	Drain Source Voltage	1200	V
$V_{GS,max}$	Gate Source Voltage, Absolute Maximum Values	-8 / +22	V
$V_{GS,op}$	Gate Source Voltage, Recommended Operational Values	-4 / +15	V
$I_D$	Continuous Drain Current @ $T_C = 25^\circ C$	87	A
	Continuous Drain Current @ $T_C = 100^\circ C$	62	
$I_{D(puls)}$	Pulsed Drain Current, Pulse Width $t_P$ limited by $T_{j,max}$	188	
$P_D$	Power Dissipation @ $T_C = 25^\circ C, T_J = 175^\circ C$	375	W
$T_J, T_{STG}$	Operating Junction and Storage Temperature Range	-55 to +175	$^\circ C$
$T_L$	Soldering Temperature	260	$^\circ C$

**Thermal Resistance**

Symbol	Characterizes	Typ.	Max.	Units
R <sub>θJC</sub>	Thermal Resistance, Junction-to-case	—	0.4	°C/W
R <sub>θJA</sub>	Thermal Resistance, Junction-to-ambient	—	37	°C/W

**Electrical Characteristics @T<sub>A</sub>=25°C unless otherwise specified**

Symbol	Parameter	Min.	Typ.	Max.	Units	Conditions
V <sub>(BR)DSS</sub>	Drain-to-Source Breakdown Voltage	1200	—	—	V	V <sub>GS</sub> = 0V, I <sub>D</sub> = 100μA
R <sub>DS(on)</sub>	Static Drain-to-Source On-resistance	—	32	40	mΩ	V <sub>GS</sub> =15V, I <sub>D</sub> = 40A
		—	49	—		V <sub>GS</sub> =15V, I <sub>D</sub> =40A, T <sub>J</sub> =175°C
		—	27	34		V <sub>GS</sub> =18V, I <sub>D</sub> = 40A
		—	47	—		V <sub>GS</sub> =18V, I <sub>D</sub> =40A, T <sub>J</sub> = 175°C
V <sub>GS(th)</sub>	Gate Threshold Voltage	2.3	—	3.6	V	V <sub>DS</sub> = V <sub>GS</sub> , I <sub>D</sub> = 11.5mA
I <sub>DSS</sub>	Drain-to-Source Leakage Current	—	—	10	μA	V <sub>DS</sub> = 1200V, V <sub>GS</sub> = 0V
I <sub>GSS</sub>	Gate-to-Source Forward Leakage	—	—	100	nA	V <sub>GS</sub> =15V
		—	—	-100		V <sub>GS</sub> = -15V
g <sub>fs</sub>	Transconductance	—	24	—	S	V <sub>DS</sub> = 20V, I <sub>D</sub> =40A
R <sub>g</sub>	Internal Gate Resistance	—	0.6	—	Ω	V <sub>AC</sub> = 25mV, f =1MHz
Q <sub>g</sub>	Total Gate Charge	—	96	—	nC	V <sub>DS</sub> = 800V, V <sub>GS</sub> = -4/+15V, I <sub>D</sub> = 40A
Q <sub>gs</sub>	Gate-to-Source Charge	—	25.5	—		
Q <sub>gd</sub>	Gate-to-Drain("Miller") Charge	—	30	—		
t <sub>d(on)</sub>	Turn-on Delay Time	—	15	—	ns	V <sub>DS</sub> = 800V, V <sub>GS</sub> =-4/+15V I <sub>D</sub> = 40A, R <sub>g</sub> = 2.5Ω L = 120uH
t <sub>r</sub>	Rise Time	—	20	—		
t <sub>d(off)</sub>	Turn-Off Delay Time	—	25	—		
t <sub>f</sub>	Fall Time	—	10	—		
E <sub>on</sub>	Turn on Switching Energy	—	410	—	μJ	
E <sub>off</sub>	Turn off Switching Energy	—	60	—		
C <sub>iss</sub>	Input Capacitance	—	2700	—	pF	V <sub>GS</sub> = 0V V <sub>DS</sub> = 1000V f =100KHz
C <sub>oss</sub>	Output Capacitance	—	140	—		
C <sub>riss</sub>	Reverse Transfer Capacitance	—	10	—		
E <sub>oss</sub>	Coss Stored Energy	—	90	—		

**Electrical Characteristics of the Diode @T<sub>A</sub>=25°C unless otherwise specified**

Symbol	Parameter	Min.	Typ.	Max.	Units	Conditions
I <sub>S</sub>	Continuous diode forward current	—	87	—	A	V <sub>GS</sub> = -4V, T <sub>c</sub> = 25°C
V <sub>SD</sub>	Diode Forward Voltage	—	3.8	—	V	V <sub>GS</sub> = -4V, I <sub>SD</sub> = 20A
t <sub>rr</sub>	Reverse recovery time	—	55	—	ns	V <sub>R</sub> = 800V, V <sub>GS</sub> = -4V I <sub>D</sub> = 40A, di/dt = 2281A/μS, T <sub>J</sub> = 175°C
Q <sub>rr</sub>	Reverse Recovery Charge	—	750	—	nC	
I <sub>RRM</sub>	Diode Peak Reverse Recovery Current	—	26	—	A	

Typical Electrical and Thermal Characteristics

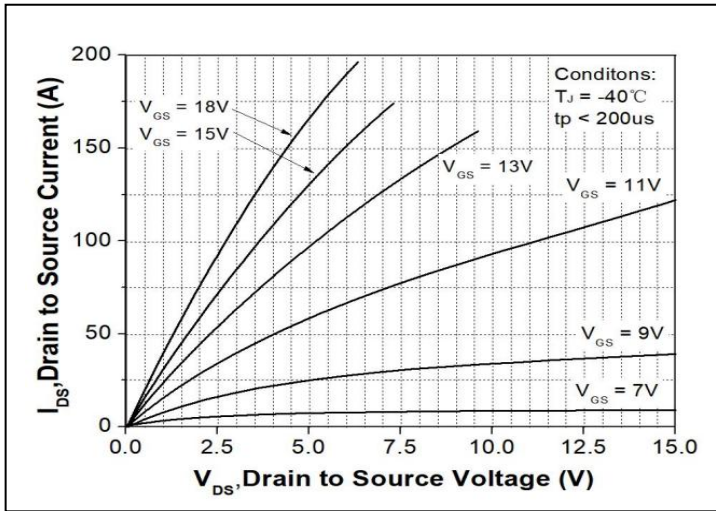

Figure1. Typical Output Characteristics@ $T_J = -40^\circ\text{C}$

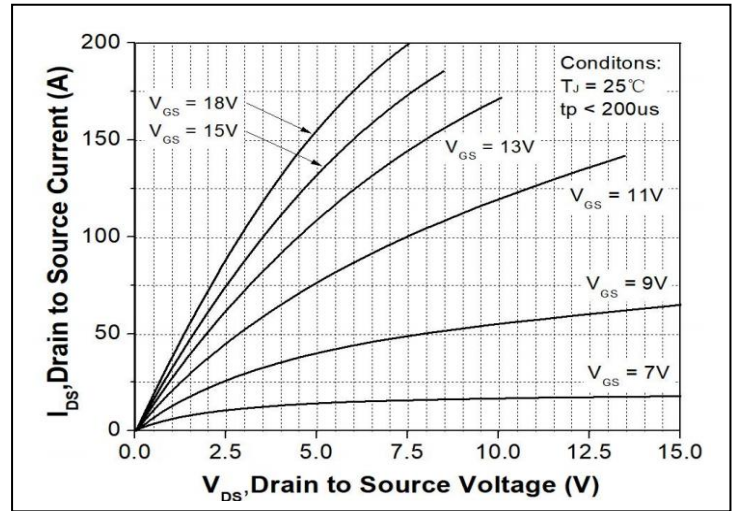

Figure2. Typical Output Characteristics@ $T_J = 25^\circ\text{C}$

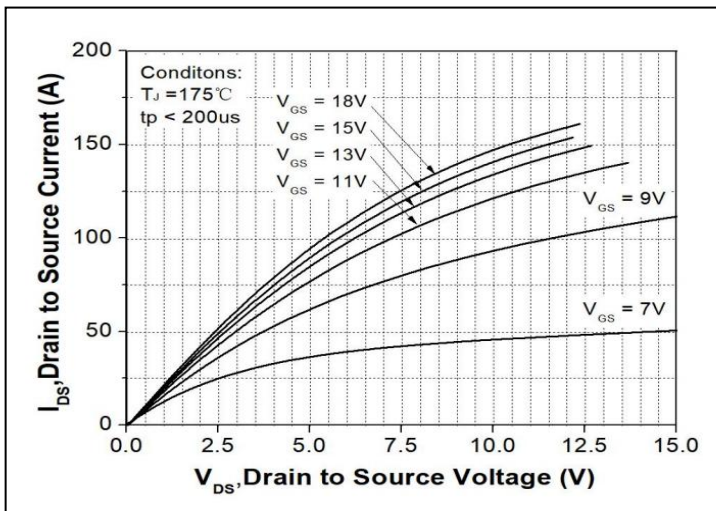

Figure3. Typical Output Characteristics@ $T_J = 175^\circ\text{C}$

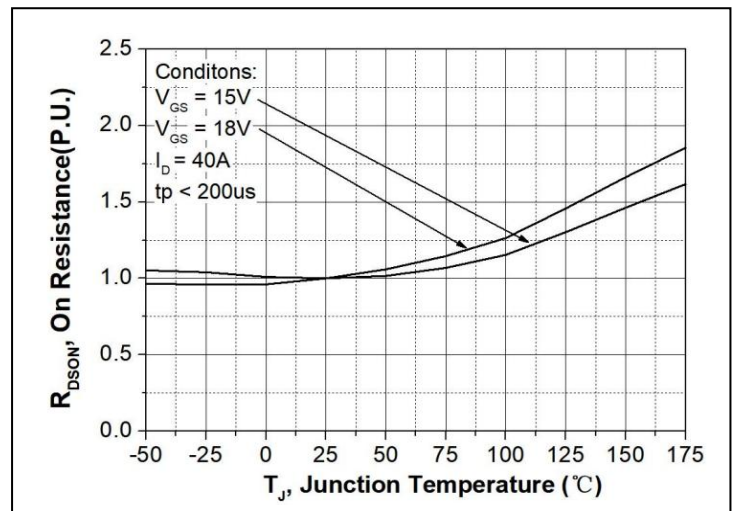

Figure4. Normalized on-resistance vs. Temperature

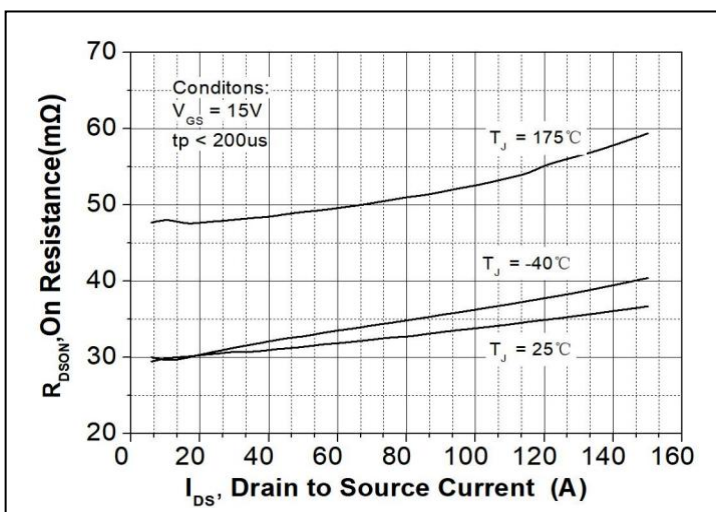

Figure5. On-resistance vs. Drain Current

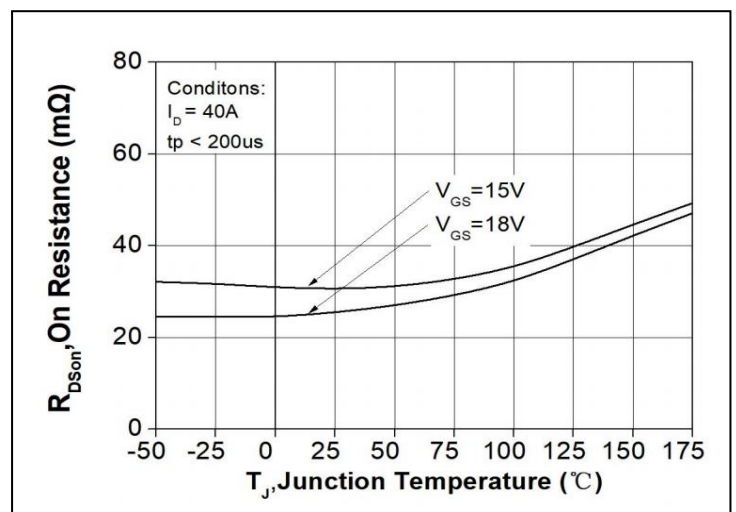

Figure6. On-resistance vs. Temperature

Typical Electrical and Thermal Characteristics

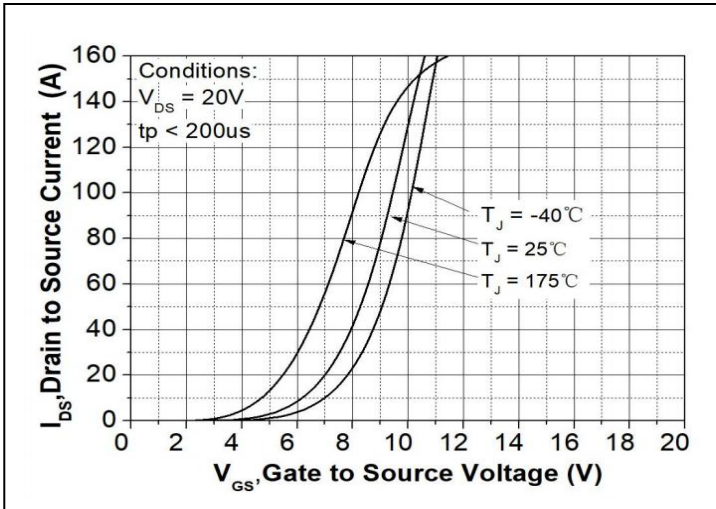

Figure7.Transfer Characteristic for Various Junction Temperatures

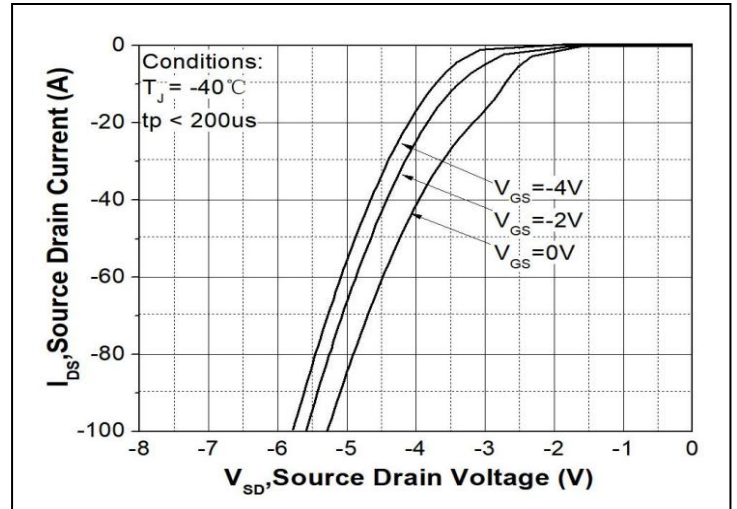

Figure8.Body Diode Characteristic @T<sub>J</sub> = -40 °C

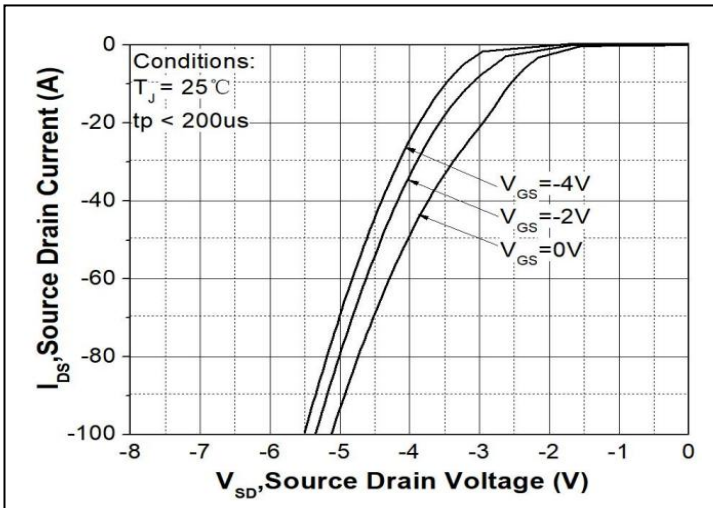

Figure9.Body Diode Characteristic @T<sub>J</sub> = 25 °C

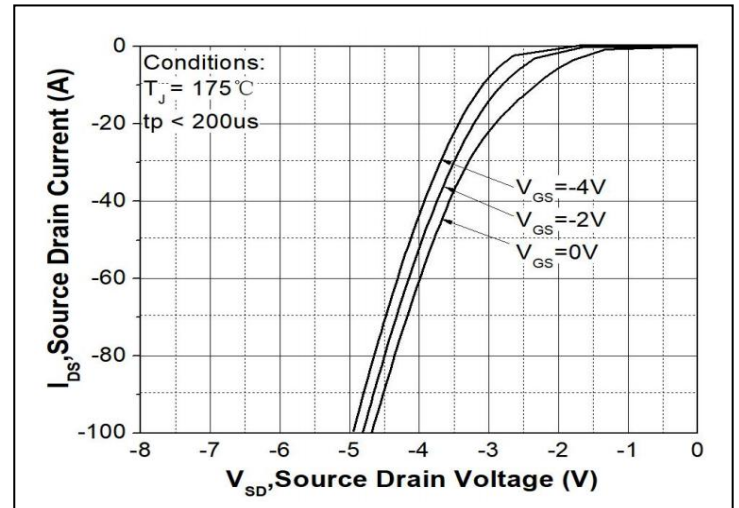

Figure10.Body Diode Characteristic @T<sub>J</sub> = 175 °C

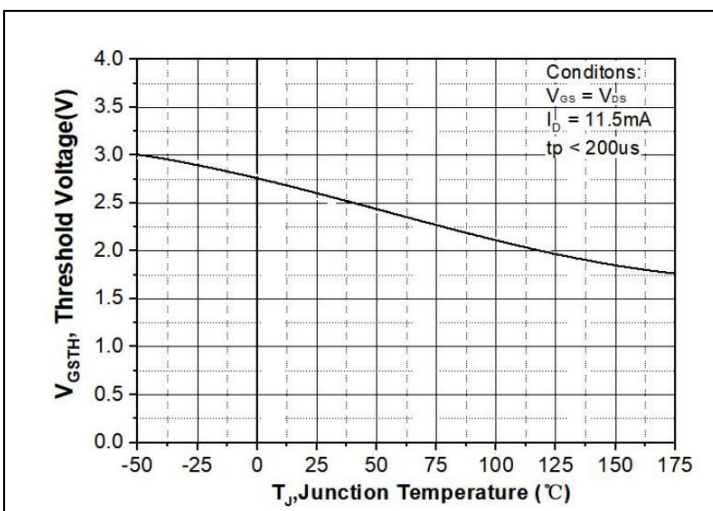

Figure11.Threshold Voltage vs. Temperature

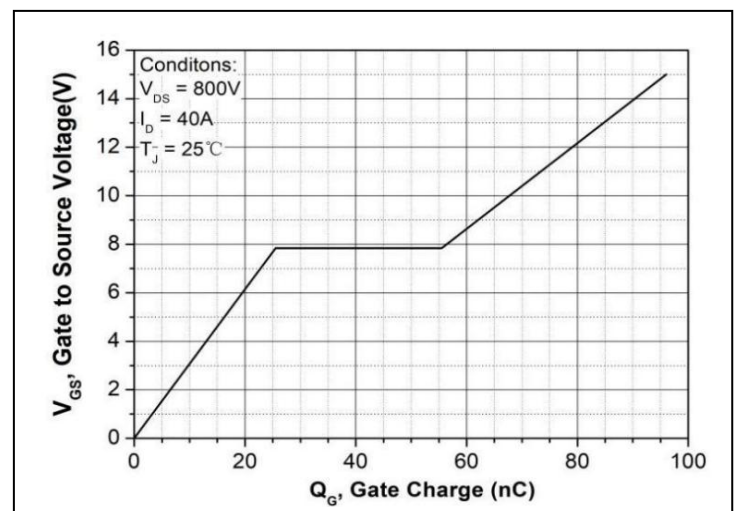

Figure12.Gate Charge Characteristic

Typical Electrical and Thermal Characteristics

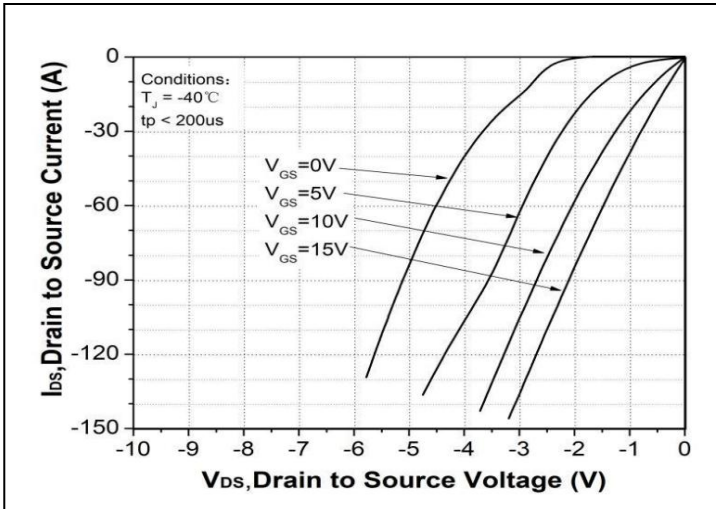

Figure13.3rd Quadrant Characteristic @ T<sub>J</sub> = -40 °C

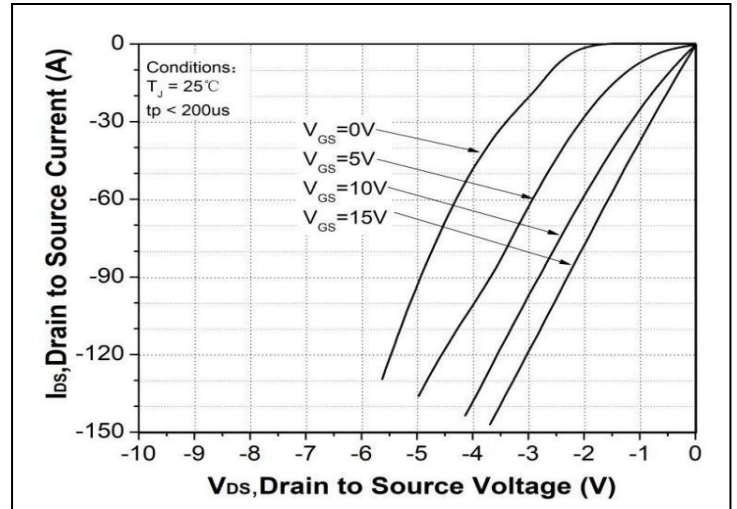

Figure14.3rd Quadrant Characteristic @ T<sub>J</sub> = 25 °C

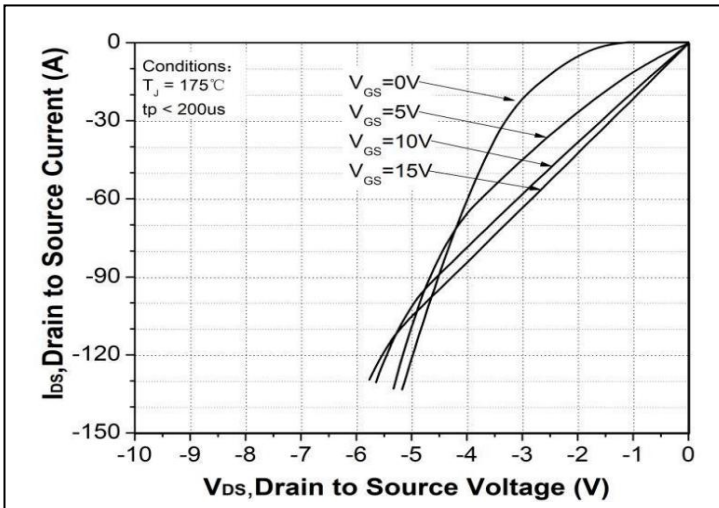

Figure15.3rd Quadrant Characteristic @ T<sub>J</sub> = 175 °C

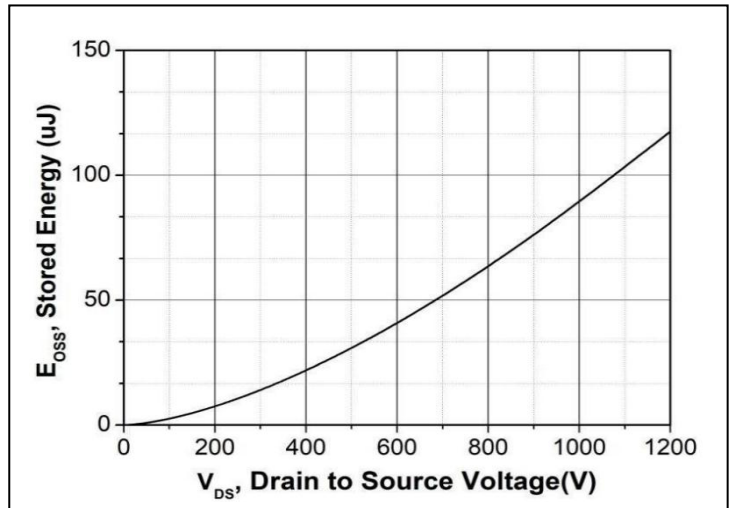

Figure16.Output Capacitor Stored Energy

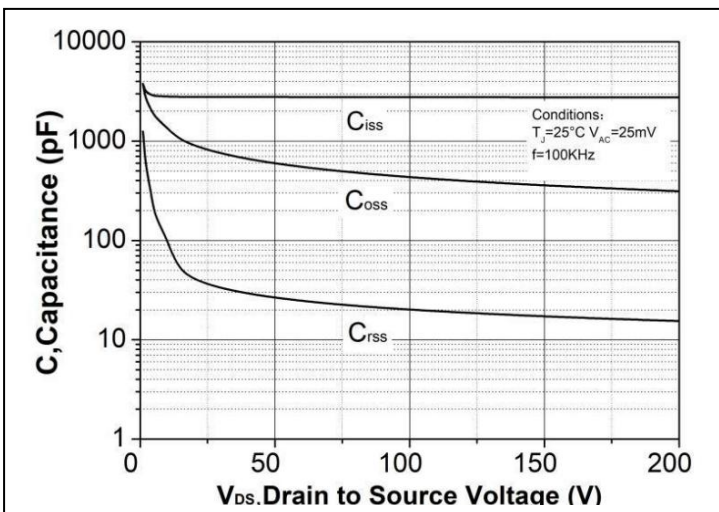

Figure17.Capacitances vs. Drain-source Voltage (0~200V)

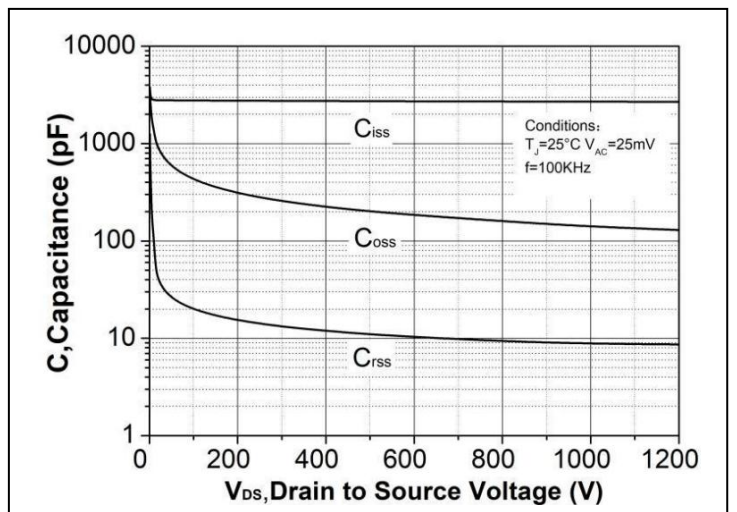

Figure18.Capacitances vs. Drain-source Voltage (0~1200V)

Typical Electrical and Thermal Characteristics

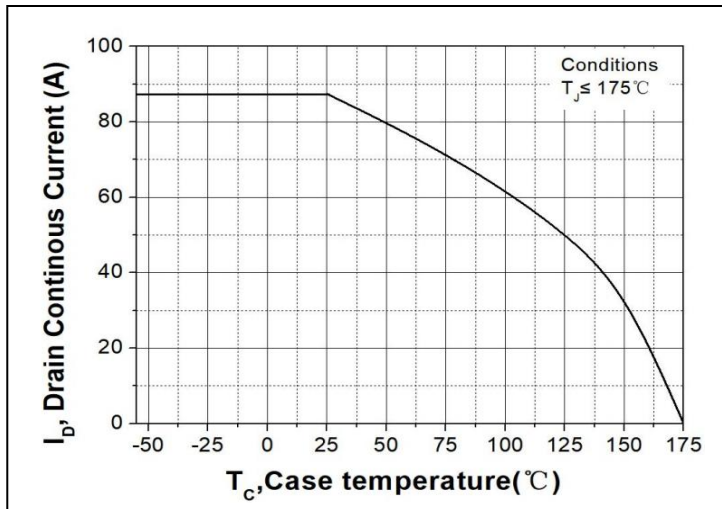

Figure19.Continuous Drain Current Derating vs.Case Temperature

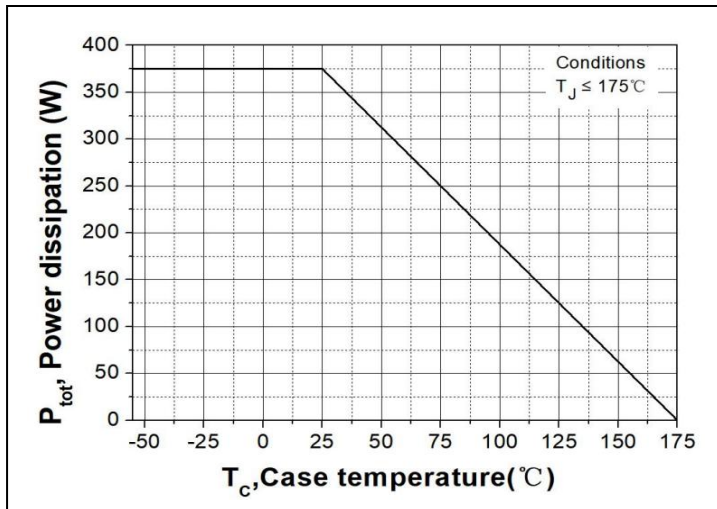

Figure20.Maximum Power Dissipation Derating vs. Case Temperature

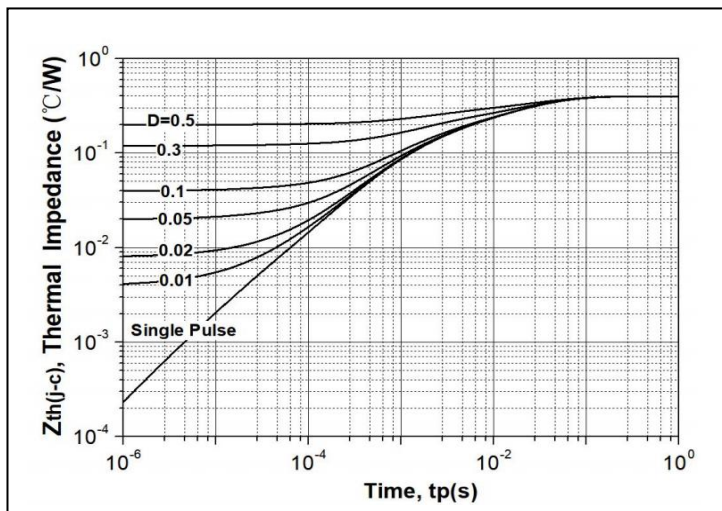

Figure21.Transient Thermal Impedance (Junction - Case)

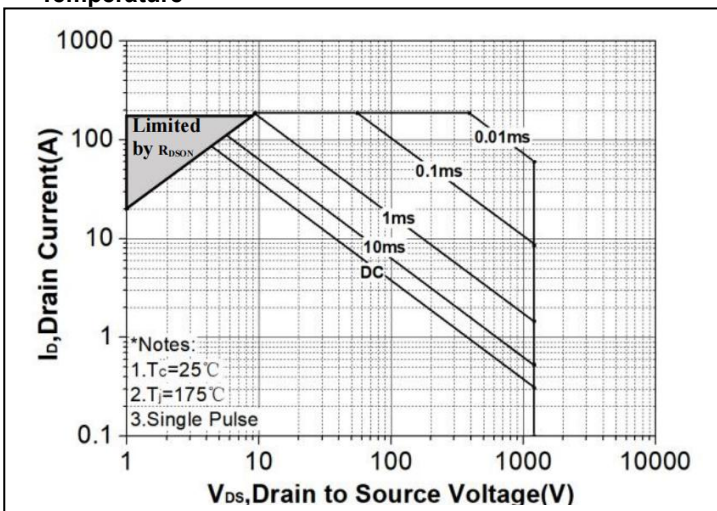

Figure22.Output Capacitor Stored Energy

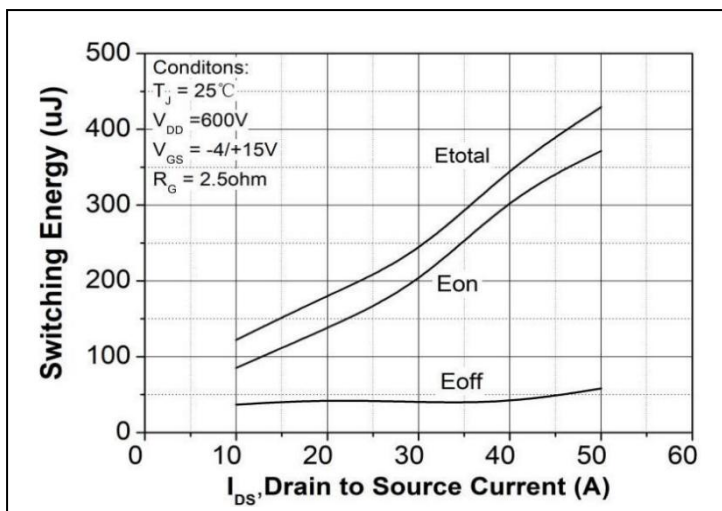

Figure23.Clamped Inductive Switching Energy vs. Drain Current (VDD = 600V)

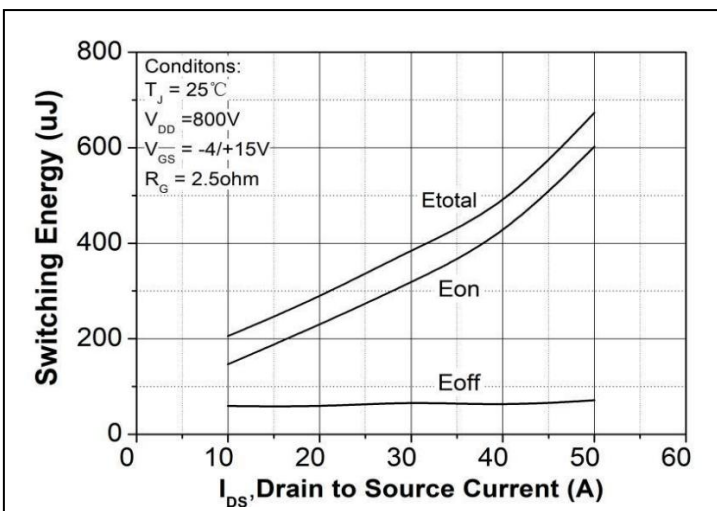

Figure24.Clamped Inductive Switching Energy vs. Drain Current (VDD = 800V)

Typical Electrical and Thermal Characteristics

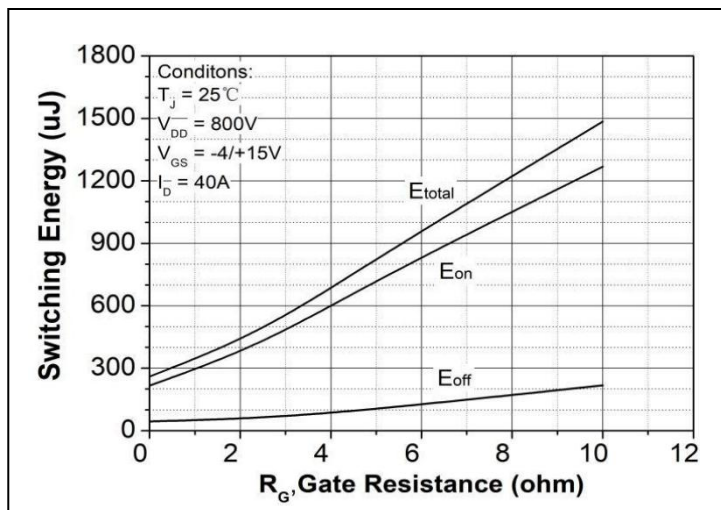

Figure25.Clamped Inductive Switching Energy vs.  $R_G$ (ext)

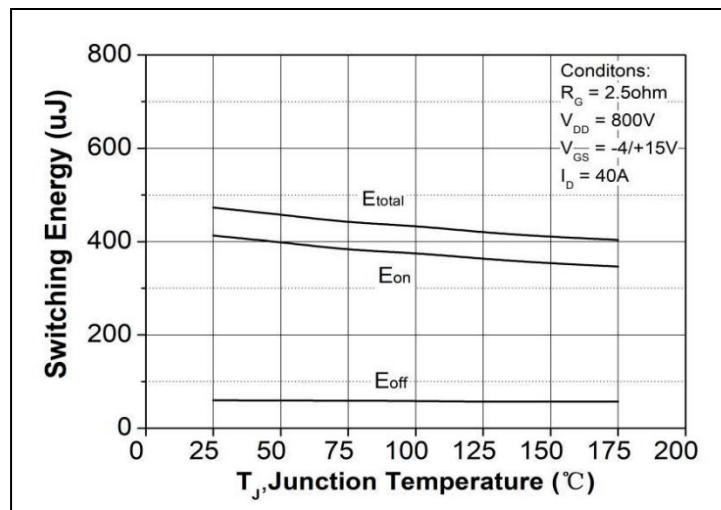

Figure26.Clamped Inductive Switching Energy vs. Temperature

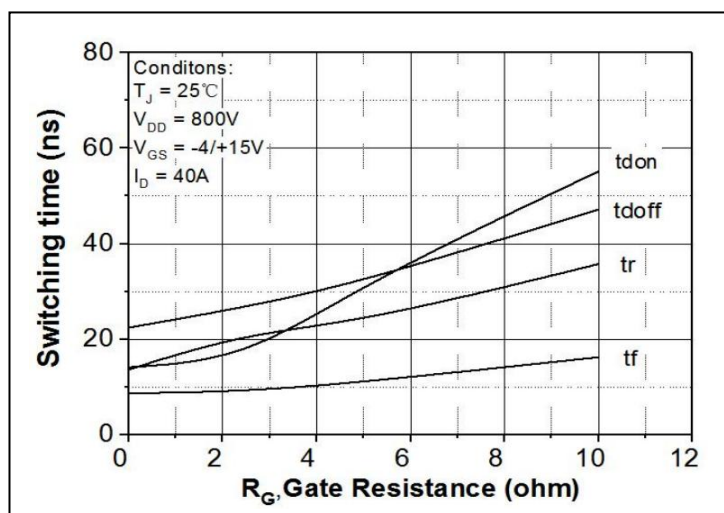
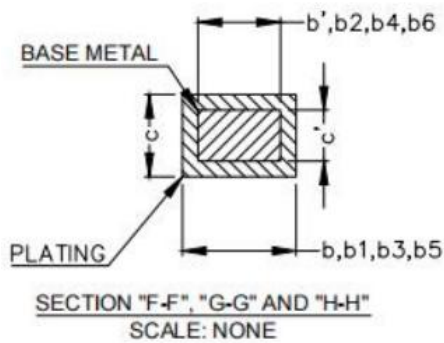
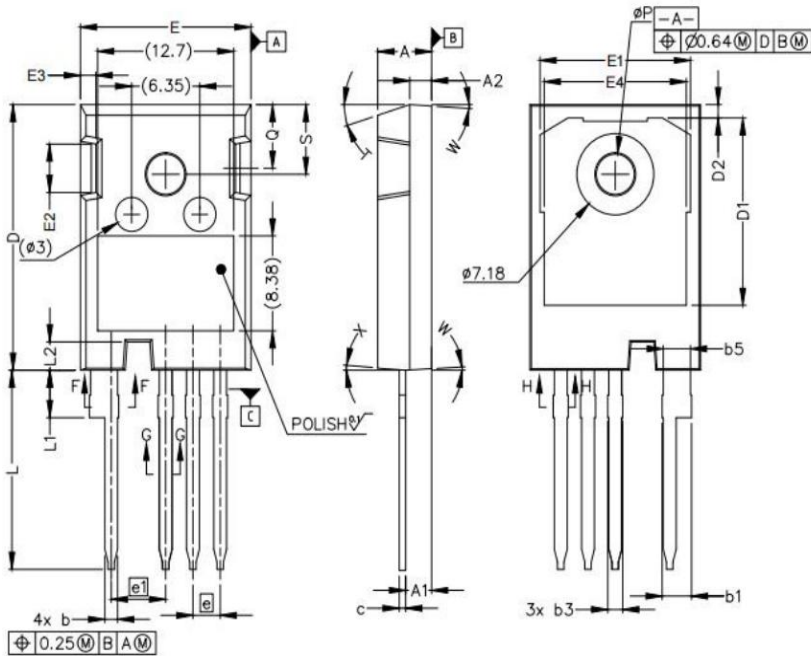

Figure27.Switching Times vs.  $R_G$ (ext)

**Mechanical Data:**

Unit:mm



SYMBOL	MILLIMETERS	
	MIN	MAX
A	4.83	5.21
A1	2.29	2.54
A2	1.91	2.16
b'	1.07	1.28
b	1.07	1.33
b1	2.39	2.94
b2	2.39	2.84
b3	1.07	1.60
b4	1.07	1.50
b5	2.39	2.69
b6	2.39	2.64
c'	0.55	0.65
c	0.55	0.68
D	23.30	23.60
D1	16.25	17.65
D2	0.95	1.25
E	15.75	16.13
E1	13.10	14.15
E2	3.68	5.10
E3	1.00	1.90
E4	12.38	13.43
e	2.54 BSC	
e1	5.08 BSC	
N	4	
L	17.31	17.82
L1	3.97	4.37
L2	2.35	2.65
$\phi P$	3.51	3.65
Q	5.49	6.00
S	6.04	6.30
T	17.5° REF.	
W	3.5° REF.	
X	4° REF.	



**ATTENTION:**

- Any and all Silikron products described or contained herein do not have specifications that can handle applications that require extremely high levels of reliability, such as life-support systems, aircraft's control systems, or other applications whose failure can be reasonably expected to result in serious physical and/or material damage. Consult with your Silikron representative nearest you before using any Silikron products described or contained herein in such applications.
- Silikron assumes no responsibility for equipment failures that result from using products at values that exceed, even momentarily, rated values (such as maximum ratings, operating condition ranges, or other parameters) listed in products specifications of any and all Silikron products described or contained herein.
- Specifications of any and all Silikron products described or contained herein stipulate the performance, characteristics, and functions of the described products in the independent state, and are not guarantees of the performance, characteristics, and functions of the described products as mounted in the customer's products or equipment. To verify symptoms and states that cannot be evaluated in an independent device, the customer should always evaluate and test devices mounted in the customer's products or equipment.
- Silikron Microelectronics (Suzhou) Co.,Ltd. strives to supply high-quality high-reliability products. However, any and all semiconductor products fail with some probability. It is possible that these probabilistic failures could give rise to accidents or events that could endanger human lives, that could give rise to smoke or fire, or that could cause damage to other property. When designing equipment, adopt safety measures so that these kinds of accidents or events cannot occur. Such measures include but are not limited to protective circuits and error prevention circuits for safe design, redundant design, and structural design.
- In the event that any or all Silikron products(including technical data, services) described or contained herein are controlled under any of applicable local export control laws and regulations, such products must not be exported without obtaining the export license from the authorities concerned in accordance with the above law.
- No part of this publication may be reproduced or transmitted in any form or by any means, electronic or mechanical, including photocopying and recording, or any information storage or retrieval system, or otherwise, without the prior written permission of Silikron Microelectronics (Suzhou) Co.,Ltd.
- Information (including circuit diagrams and circuit parameters) herein is for example only ; it is not guaranteed for volume production. Silikron believes information herein is accurate and reliable, but no guarantees are made or implied regarding its use or any infringements of intellectual property rights or other rights of third parties.
- Any and all information described or contained herein are subject to change without notice due to product/technology improvement, etc. When designing equipment, refer to the "Delivery Specification" for the Silikron product that you intend to use.